

ZAXIS-6 series

HITACHI

Reliable solutions

ZAXIS210



HYDRAULIC EXCAVATOR

Model code : ZX210-6 / ZX210LC-6 / ZX210LCN-6

Engine rated power : 128.4 kW (ISO14396)

Operating weight : 21 600 – 23 700 kg

Bucket ISO heaped : 0.51 – 1.20 m³

ZX210LC-6. NO COMPROMISE

The Zaxis-6 medium excavator range benefits from unique Hitachi technology. This enables the innovative ZX210LC-6 to deliver a high level of performance without compromising on the increasing demand for operational efficiency.

Over several decades, Hitachi has built a strong reputation based on the quality of its engineering, and the reliability and durability of its construction machinery. The ZX210LC-6 lives up to this reputation and is suitable for a wide range of industry solutions, thanks to its incredibly versatile features.



6. RENOWNED FOR RELIABILITY



8. BUILT-IN DURABILITY



10. EPITOME OF VERSATILITY



12. QUALITY GUARANTEED



14. UNIQUE TECHNOLOGY

DEMAND PERFECTION

The Hitachi ZX210LC-6 has been designed in Japan at the world's biggest excavator factory for the specific needs of the European construction industry. It has been developed to perfection using market-leading technology to deliver exceptional productivity at the lowest possible cost of ownership.



Optimum performance

Remote monitoring with Global e-Service online application.



High quality

Only the best design elements and materials.



Incredible versatility

Tilt and rotary tilt modes complete the attachment support system.



Lifetime reliability

Reliable components help to prevent oil leaks.



Ultimate durability

Redesigned lower roller reduces risk of damage.





User-friendly

Safety comes first with handrails and a reinforced safety platform.



Low emissions

SCR system reduces NOx from exhaust gas.



Low fuel consumption

8% fuel saving in ECO mode (6% in PWR mode).



Excellent efficiency

TRIAS II system reduces total hydraulic loss.



Engine protection

High performance and large-capacity fuel circuit.



Easy maintenance

Convenient and wide-opening engine cover.



“ *Hitachi is recognised in the industry as a top brand* ”

Eamonn McGurk, owner, Keyway Group

RENOWNED FOR RELIABILITY

The ZX210LC-6 has been designed to work on a wide range of demanding job sites all day, every day. High levels of availability and performance, exceptional efficiency, and a variety of easy maintenance features, contribute to a profitable return on investment.

Easy maintenance

The engine cover can be conveniently opened up fully from the platform. This provides easy access to the engine compartment and other components for routine maintenance.

Durable hydraulic connection

A rubber hose fitted with a flange has been incorporated into the design of the hydraulic return pipes. These enhance the reliability of the system and reduce the risk of oil leaks.

User-friendly fuel filter

The main fuel filter screws into place on the ZX210LC-6. This makes it easier to replace and ensures that dust is prevented from entering the fuel circuit during routine maintenance procedures.

More efficient cooling

The expansion tank is mounted on top of the engine's cooling system. This revised position means that the air can be completely removed and prevents the engine parts from overheating.



Easy access to the engine compartment.



The main fuel filter is easier to replace.



The expansion tank prevents engine parts from overheating.



HITACHI

ZA15
210^{LC}



Redesigned lower roller prevents mud entering and causing damage.



Improved performance derived from the fuel circuit.



i The durability of Hitachi excavators is tested at Urahoro Test Site on Hokkaido, the northernmost Japanese island, in job site conditions and temperatures from -25°C to 35°C.



BUILT-IN DURABILITY

Hitachi construction machinery is renowned as the most reliable and durable on the market. The Zaxis-6 medium excavator range has been developed using decades of manufacturing experience. As a result, it is designed and engineered to operate in the most challenging environments.



Durable design

The lower roller of the ZX210LC-6 has been redesigned to prevent mud from entering and causing damage to the oil seal. This enhances the long-term durability of the machine.

Enhanced fuel circuit

A high performance water separator and cold fuel resistance valve are integrated into the pre-filter for added protection against moisture. In addition, a large capacity electric fuel pump supplies an appropriate amount of fuel to the engine for an improved performance.

Engine protection

The combustion chamber is made from stronger materials and the revised shape of

the piston is designed to achieve cleaner emissions. These features will further enhance the reliability of the engine.

Oil leak prevention

The O-rings on the control valve and swing motor are made from fluorine. This highly durable material withstands high oil temperatures and reinforces the parts' reliability to prevent oil leaks.

Reinforced platform

The covers on the platform walkway have been reinforced. This adds to the high-quality and safe working environment, which provides peace of mind for the operator.



Reinforced for safer working environment.





“ *It is stable, powerful and the rear-view camera is ideal* ”

Rune Morten Ryen, operator, Skogen

EPITOME OF VERSATILITY

The ZX210LC-6 is among the most popular models of the Hitachi medium excavator range, thanks to its power, performance and suitability for a wide range of construction applications. Smooth, fast and precise, it delivers high levels of productivity and fuel efficiency.

Greater flexibility

The rotary tilt and tilt modes are included within the attachment support system on the ZX210LC-6. These and nine other modes can be registered on the monitor for the easy fitment of attachments to increase versatility.

Power boost

The tried-and-tested power-boost feature has 10% more capacity than the ZX210LC-3. This increases the capability of the ZX210LC-6 to deliver an enhanced level of excavating performance and lifting power.

User-friendly

An optional pilot accumulator allows for the pressure in the attachment circuit to be

lowered after the engine has stopped. This ensures the safe and easy replacement of attachments.

Better visibility

There are fewer bars on the optional front guard and those remaining are reduced in size – yet retain their rigidity. This helps to minimise any blind spots and improves the operator's visibility.

Machine performance

The ZX210LC-6 is equipped with two extra spools in the control valve. This increases versatility by making it easier to install attachments that require multiple, large volumes of oil and on two-piece boom models.



Two tilt modes add to the versatility of the ZX210LC-6.



Power boost has 10% more capacity.



Minimal blind spots improve visibility.



Superior weather resistance maintains the cab's internal appearance.



Urea is injected into the exhaust gas to reduce emissions.

i Tsuchiura Works Quality Assurance Centre gathers customer feedback, liaises with the Design Centre, and tests prototypes for performance, reliability and safety.



QUALITY GUARANTEED

Zaxis-6 medium excavators are manufactured from materials of the highest quality and checked for optimum performance, reliability and safety at Hitachi's Tsuchiura Works factory, the largest facility of its kind. So owners of the Hitachi ZX210LC-6 can be assured of the utmost quality in their machine.



Ergonomic controls contribute to the ultimate workspace.

Superior cooling performance

The upper structure benefits from high-quality sealant (around the cooling package) and acoustic materials to eliminate any deterioration caused by heat. These ensure the long-term cooling and low-noise acoustic performance of the ZX210LC-6.

Excellent weather resistance

The cab console has been sculpted in highly durable AES-grade resin. This ensures superior weather resistance and ultimately prevents the sun's ultraviolet rays from damaging the console.

Reduced emissions

Hitachi has developed a selective catalytic reduction (SCR) system that injects urea into exhaust gas to reduce nitrogen

oxide from emissions. This cutting-edge technology not only helps the environment, but also complies with EU Stage IV emission regulations.

Ultimate comfort

A fully adjustable seat, spacious cab, ergonomic controls and advanced music system all contribute to the ultimate working environment.

Safety at work

The ZX210LC-6 has been fitted with a high-spec rollover protective structure-compliant (ROPS) and centre pillar reinforced structure (CRES V) cab. The pressurised cab is designed to protect the operator from the penetration of dust and potential job site risks.



“ *Hitachi is the only manufacturer to possess a high level of expertise in tuning the [TRIAS] hydraulic system* ”

Burkhard Janssen, General Manager Product Management & Engineering, Hitachi Construction Machinery (Europe) NV

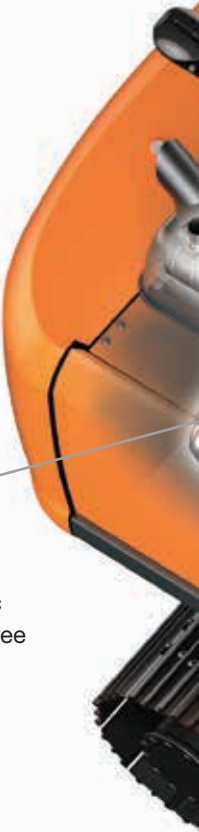

The TRIAS II hydraulic system consists of three pumps and valves.

UNIQUE TECHNOLOGY

Hitachi Zaxis-6 medium excavators benefit from unique Hitachi technology, developed to maximise efficiency and improve overall performance. Examples of this can be found in every part of the ZX210LC-6, from the engine and hydraulics, to inside the cab. This emphasis on technology sets Hitachi apart from the competition.

Saving fuel and costs

Hydraulic loss is decreased by TRIAS II technology. It reduces the hydraulic oil returned to the tank due to the cooperative control of the pump and valve. This helps to lower fuel consumption by 8% in ECO mode with the same productivity.

User-friendly functionality

A large seven-inch multi-function LCD monitor provides a wide range of useful technical information. With multi-lingual support in up to 32 languages, it enables operators to check the machine's status and settings at a glance.

Remote monitoring

Global e-Service allows owners to monitor their fleets remotely via Owner's Site (24/7 online access) and ConSite (an automatic monthly report). These help to maximise efficiency, minimise downtime and improve overall performance.

Fewer emissions

The after-treatment device consists of a diesel oxidation catalyst (DOC), urea mixing pipe, SCR system and silencer. This advanced technology helps to reduce emissions and noise levels.

Advanced audio system

The AM/FM radio is accessible from the monitor and an auxiliary socket – for devices such as MP3 players – is linked to the sound system. This choice of entertainment helps to provide an enjoyable – and productive – working environment.

The oil flows separately to the bucket (light blue), arm (dark blue) and boom (yellow) cylinders.

The front attachment moves faster, because each actuator has its own pump.

The pumps are controlled electrically for precise oil flow and lower fuel consumption.

The SCR system injects urea into exhaust gas (red) to reduce nitrogen oxide from emissions.



8% lower fuel consumption in ECO mode with TRIAS II.



The LCD monitor shows the machine's status and settings.

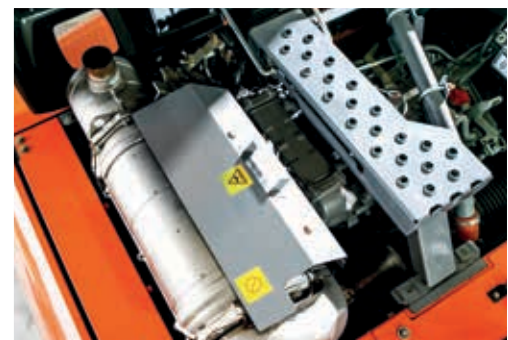

The SCR system reduces emissions and noise levels.



“ *The total cost of ownership is of maximum benefit to our company* ”

Peter Kögel, Member of the Management Board,
Kögel Bau GmbH & Co. KG

REDUCING THE TOTAL COST OF OWNERSHIP



Hitachi has created the Support Chain after-sales programme to ensure optimum efficiency, as well as minimal downtime, reduced running costs and high resale values.

Global e-Service

Hitachi has developed two remote monitoring systems as part of its Global e-Service online application. Owner's Site and ConSite are an integral part of the excavator, which sends operational data daily via GPRS or satellite to www.globaleservice.com. This allows immediate access to the Owner's Site, and the vital information that is required for support on job sites.

Comparing the ratio of operating and non-operating hours helps to enhance efficiency. Effective management of maintenance programmes helps to

maximise availability. Running costs can also be managed by analysing the fuel consumption. The location and movements of each machine are clearly displayed for essential planning.

An automatic service report – ConSite – sends a monthly email summarising the information from Global e-Service for each machine. This includes: daily working hours and fuel consumption data; statistics on the operating mode ratio, plus a comparison for fuel consumption/efficiency, and CO₂ emissions.

Technical support

Each Hitachi service technician receives full technical training from HCME in Amsterdam. These sessions provide access to the same technical knowledge available within the Hitachi quality assurance departments and design centres. Technicians combine this global expertise with the local language and culture of the customer to provide the highest level of after-sales support.

Extended warranty and service contracts

Every new Hitachi Zaxis-6 model is covered by a full manufacturer's warranty. For

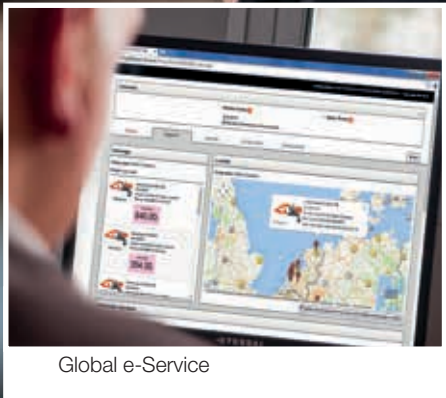

Global e-Service



Technical support



Hitachi Parts

extra protection – due to severe working conditions or to minimise equipment repair costs – Hitachi dealers offer a unique extended warranty called HELP (Hitachi Extended Life Program) and comprehensive service contracts. These can help to optimise the performance of each machine, reduce downtime and ensure higher resale values.

Parts

Hitachi offers a wide range and a high availability of parts dispatched from the

53,000 m² HCME European Parts Depot in The Netherlands.

- Hitachi Genuine Parts: allow machines to work for longer, with lower running and maintenance costs.
- Hitachi Select Parts and 2Genuine Parts: especially for older machines, they cost less, are of proven quality and come with the manufacturer’s warranty.

- Performance Parts: to cope with highly demanding conditions, they have been engineered for greater durability, better performance or longer life.
- Remanufactured components: offering an economically viable solution, they are the best option when preventative replacements are required.

Whatever the choice, the renowned quality of Hitachi construction machinery is assured.



EH dump trucks



EX ultra-large excavators



ZW wheel loaders



“ We develop construction machinery that contributes to the creation of affluent and comfortable societies ”

Yuichi Tsujimoto, HCM President

BUILDING A BETTER FUTURE

Established in 1910, Hitachi, Ltd. was built upon a founding philosophy of making a positive contribution to society through technology. This is still the inspiration behind the Hitachi group's reliable solutions that answer today's challenges and help to create a better world.

Hitachi, Ltd. is now one of the world's largest corporations, with a vast range of innovative products and services. These have been created to challenge convention, improve social infrastructure and contribute to a sustainable society.

Hitachi Construction Machinery Co., Ltd. (HCM) was founded in 1970 as a subsidiary of Hitachi, Ltd. and has become one of the world's largest construction equipment suppliers. A pioneer in producing hydraulic excavators, HCM also manufactures wheel loaders, rigid dump trucks, crawler cranes and special application machines at state-of-the-art facilities across the globe.

Incorporating advanced technology, Hitachi construction machinery has a reputation for the highest quality standards. Suitable for a wide range of industries, it is always

hard at work around the world – helping to create infrastructure for a safe and comfortable way of living, developing natural resources and supporting disaster relief efforts.

Hitachi Zaxis excavators are renowned for being reliable, durable and versatile – capable of delivering the highest levels of productivity under the most challenging of conditions. They are designed to provide owners with a reduced total cost of ownership, and operators with the ultimate level of comfort and safety.



Mini excavators

SPECIFICATIONS

ENGINE

Model	Isuzu AR-4HK1X
Type	4-cycle water-cooled, common rail direct injection
Aspiration	Variable geometry turbocharged, intercooled, cooled EGR
Aftertreatment	DOC and SCR system
No. of cylinders	4
Rated power	
ISO 14396	128.4 kW at 2 000 min ⁻¹
ISO 9249, net	122 kW at 2 000 min ⁻¹
SAE J1349, net	122 kW at 2 000 min ⁻¹
Maximum torque	670 Nm at 1 600 min ⁻¹
Piston displacement	5.193 L
Bore and stroke	115 mm x 125 mm
Batteries	2 x 12 V / 126 Ah

HYDRAULIC SYSTEM

Hydraulic Pumps

Main pumps	3 variable displacement axial piston pumps
Maximum oil flow	2 x 212 L/min 1 x 189 L/min
Pilot pump	1 gear pump
Maximum oil flow	33.6 L/min

Hydraulic Motors

Travel	2 variable displacement axial piston motors
Swing	1 axial piston motor

Relief Valve Settings

Implement circuit	34.3 MPa
Swing circuit	32.4 MPa
Travel circuit	35.5 MPa
Pilot circuit	3.9 MPa
Power boost	38.0 MPa

Hydraulic Cylinders

	Quantity	Bore	Rod diameter
Boom	2	120 mm	85 mm
Arm	1	135 mm	95 mm
Bucket	1	115 mm	80 mm
Positioning *	1	150 mm	100 mm

* : For 2-piece boom

UPPERSTRUCTURE

Revolving Frame

D-section frame for resistance to deformation.

Swing Device

Axial piston motor with planetary reduction gear is bathed in oil. Swing circle is single-row. Swing parking brake is spring-set/hydraulic-released disc type.

Swing speed	11.8 min ⁻¹
Swing torque	68 kNm

Operator's Cab

Independent spacious cab, 1 005 mm wide by 1 675 mm high, conforming to ISO* Standards.

* International Organization for Standardization

UNDERCARRIAGE

Tracks

Tractor-type undercarriage. Welded track frame using selected materials. Side frame welded to track frame. Lubricated track rollers, idlers, and sprockets with floating seals.

Track shoes with triple grousers made of induction-hardened rolled alloy. Heat-treated connecting pins with dirt seals. Hydraulic (grease) track adjusters with shock-absorbing recoil springs.

Numbers of Rollers and Shoes on Each Side

Upper rollers	2
Lower rollers	7 : ZAXIS 210 8 : ZAXIS 210LC / ZAXIS 210LCN
Track shoes	46 : ZAXIS 210 49 : ZAXIS 210LC / ZAXIS 210LCN
Track guards	2

Travel Device

Each track driven by 2-speed axial piston motor. Parking brake is spring-set/hydraulic-released disc type. Automatic transmission system: High-Low.

Travel speeds	High : 0 to 5.5 km/h Low : 0 to 3.5 km/h
---------------------	---

Maximum traction force	203 kN
------------------------------	--------

Gradeability	70% (35 degree) continuous
--------------------	----------------------------

SOUND LEVEL

Sound level in cab according to ISO 6396 LpA 69 dB(A)

External sound level according to ISO 6395 and

EU Directive 2000/14/EC LwA 101 dB(A) : ZAXIS 210 / ZAXIS 210LC
LwA 102 dB(A) : ZAXIS 210LCN

SERVICE REFILL CAPACITIES

Fuel tank	400.0 L : ZAXIS 210 / ZAXIS 210LC 330.0 L : ZAXIS 210LCN
Engine coolant	28.0 L
Engine oil	23.0 L
Swing device	6.2 L
Travel device (each side)	6.8 L
Hydraulic system	240.0 L : ZAXIS 210 / ZAXIS 210LC 220.0 L : ZAXIS 210LCN
Hydraulic oil tank	135.0 L : ZAXIS 210 / ZAXIS 210LC 115.0 L : ZAXIS 210LCN
DEF/AdBlue® tank	57.0 L : ZAXIS 210 / ZAXIS 210LC 35.0 L : ZAXIS 210LCN

WEIGHTS AND GROUND PRESSURE

Operating Weight and Ground Pressure

			ZAXIS 210 *1				ZAXIS 210LC *1			
Boom type			Monoblock		2-Piece		Monoblock		2-Piece	
Shoe type	Shoe width	Arm length	kg	kPa	kg	kPa	kg	kPa	kg	kPa
Triple grouser	600 mm	2.03 m	21 600	48	22 200	50	22 100	46	22 700	47
		2.42 m	21 600	48	22 300	50	22 200	46	22 800	47
		2.91 m	21 700	49	22 300	50	22 200	46	22 900	47
	700 mm	2.03 m	21 800	42	22 400	43	22 400	40	23 000	41
		2.42 m	21 900	42	22 500	43	22 400	40	23 100	41
		2.91 m	21 900	42	22 600	43	22 500	40	23 100	41
	800 mm	2.03 m	22 100	37	22 700	38	22 700	35	23 300	36
		2.42 m	22 100	37	22 800	38	22 700	35	23 400	36
		2.91 m	22 200	37	22 800	38	22 800	35	23 400	36
900 mm	2.03 m	-	-	-	-	23 000	31	23 600	32	
	2.42 m	-	-	-	-	23 000	31	23 700	32	
	2.91 m	-	-	-	-	23 100	32	23 700	32	

			ZAXIS 210LCN *2			
Boom type			Monoblock		2-Piece	
Shoe type	Shoe width	Arm length	kg	kPa	kg	kPa
Triple grouser	500 mm	2.03 m	21 500	54	22 100	55
		2.42 m	21 600	54	22 200	55
		2.91 m	21 600	54	22 300	56
Triple grouser	600 mm	2.03 m	21 700	45	22 300	46
		2.42 m	21 800	45	22 400	47
		2.91 m	21 900	46	22 500	47

*1 Including 0.80 m³ (ISO heaped) bucket weight (660 kg) and counterweight (4 850 kg).

*2 Including 0.80 m³ (ISO heaped) bucket weight (660 kg) and counterweight (4 700 kg).

Basic Machine Weight and Overall Width

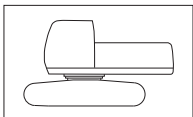

Excluding front end attachment, fuel, hydraulic oil and coolant etc. Including counterweight.

ZAXIS 210

Shoe width	Weight	Overall width
600 mm	17 100 kg	2 860 mm
700 mm	17 300 kg	2 910 mm
800 mm	17 600 kg	3 000 mm

ZAXIS 210LC

Shoe width	Weight	Overall width
600 mm	17 600 kg	2 990 mm
700 mm	17 900 kg	3 090 mm
800 mm	18 200 kg	3 190 mm
900 mm	18 500 kg	3 290 mm

ZAXIS 210LCN

Shoe width	Weight	Overall width
500 mm	17 200 kg	2 500 mm
600 mm	17 400 kg	2 580 mm

Components Weight

	Weight
Counterweight : ZAXIS 210 / ZAXIS 210LC	4 850 kg
Counterweight : ZAXIS 210LCN	4 700 kg
Monoblock boom (with arm cylinder and boom cylinder)	2 210 kg
2-Piece boom (with arm cylinder and boom cylinder)	2 930 kg
Arm 2.03 m (with bucket cylinder)	890 kg
Arm 2.42 m (with bucket cylinder)	960 kg
Arm 2.91 m (with bucket cylinder)	1 030 kg
Bucket 0.80 m ³	660 kg

BUCKET AND ARM DIGGING FORCE

Arm length	ZAXIS 210 / ZAXIS 210LC / ZAXIS 210LCN		
	2.03 m	2.42 m	2.91 m
Bucket digging force* ISO	158 kN		
Bucket digging force* SAE : PCSA	141 kN		
Arm crowd force* ISO	152 kN	140 kN	114 kN
Arm crowd force* SAE : PCSA	144 kN	133 kN	110 kN

* At power boost

SPECIFICATIONS

WORKING RANGES: MONOBLOCK BOOM

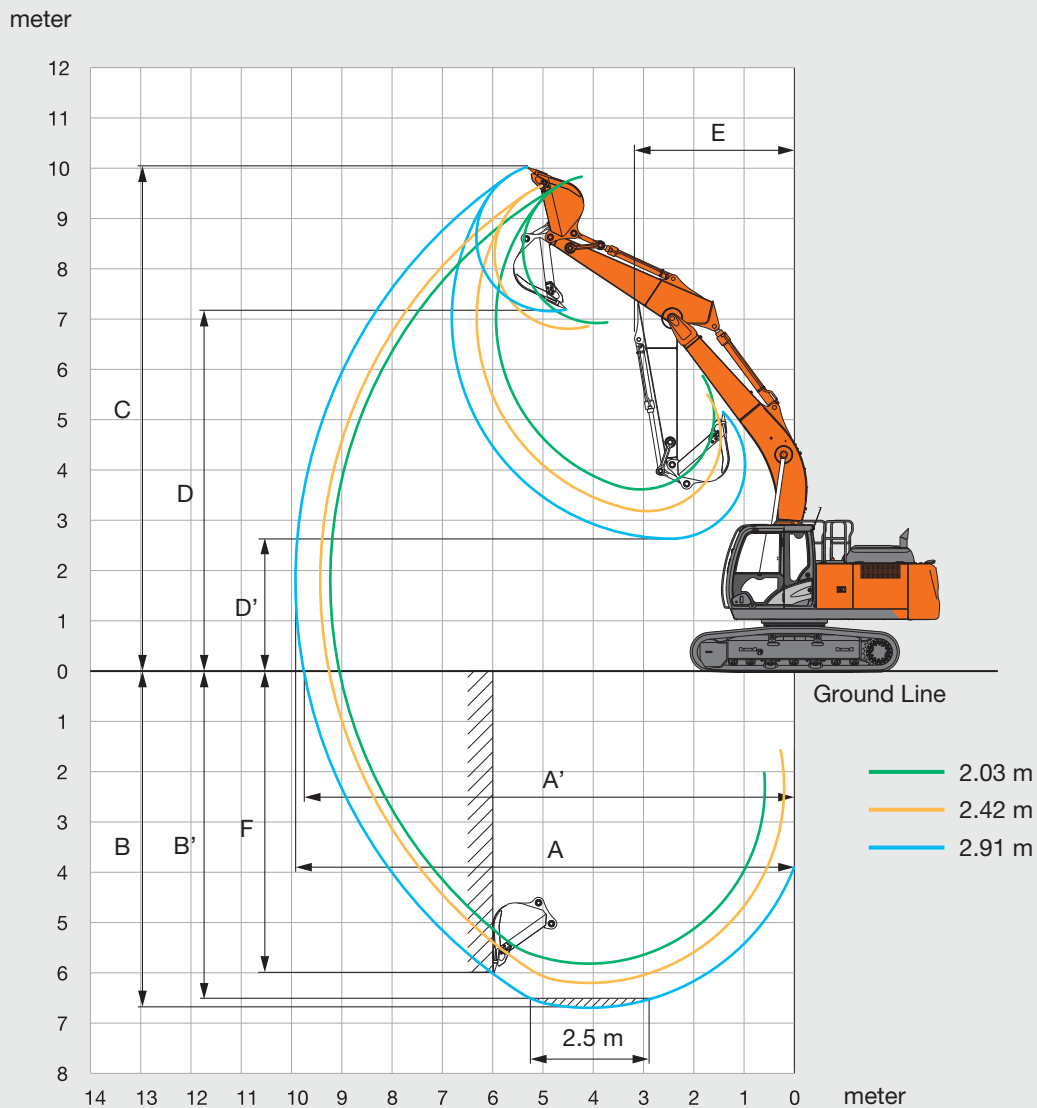

Unit: mm

	ZAXIS 210 / ZAXIS 210LC / ZAXIS 210LCN		
	Monoblock boom		
Arm length	2.03 m	2.42 m	2.91 m
A Max. digging reach	9 230	9 430	9 920
A' Max. digging reach (on ground)	9 040	9 250	9 750
B Max. digging depth	5 800	6 180	6 670
B' Max. digging depth for 2.5 m level	5 580	5 950	6 490
C Max. cutting height	9 850	9 670	10 040
D Max. dumping height	6 940	6 830	7 180
D' Min. dumping height	3 630	3 200	2 650
E Min. swing radius	3 410	3 280	3 180
F Max. vertical wall digging depth	5 210	5 300	5 990

Excluding track shoe lug

WORKING RANGES: 2-PIECE BOOM

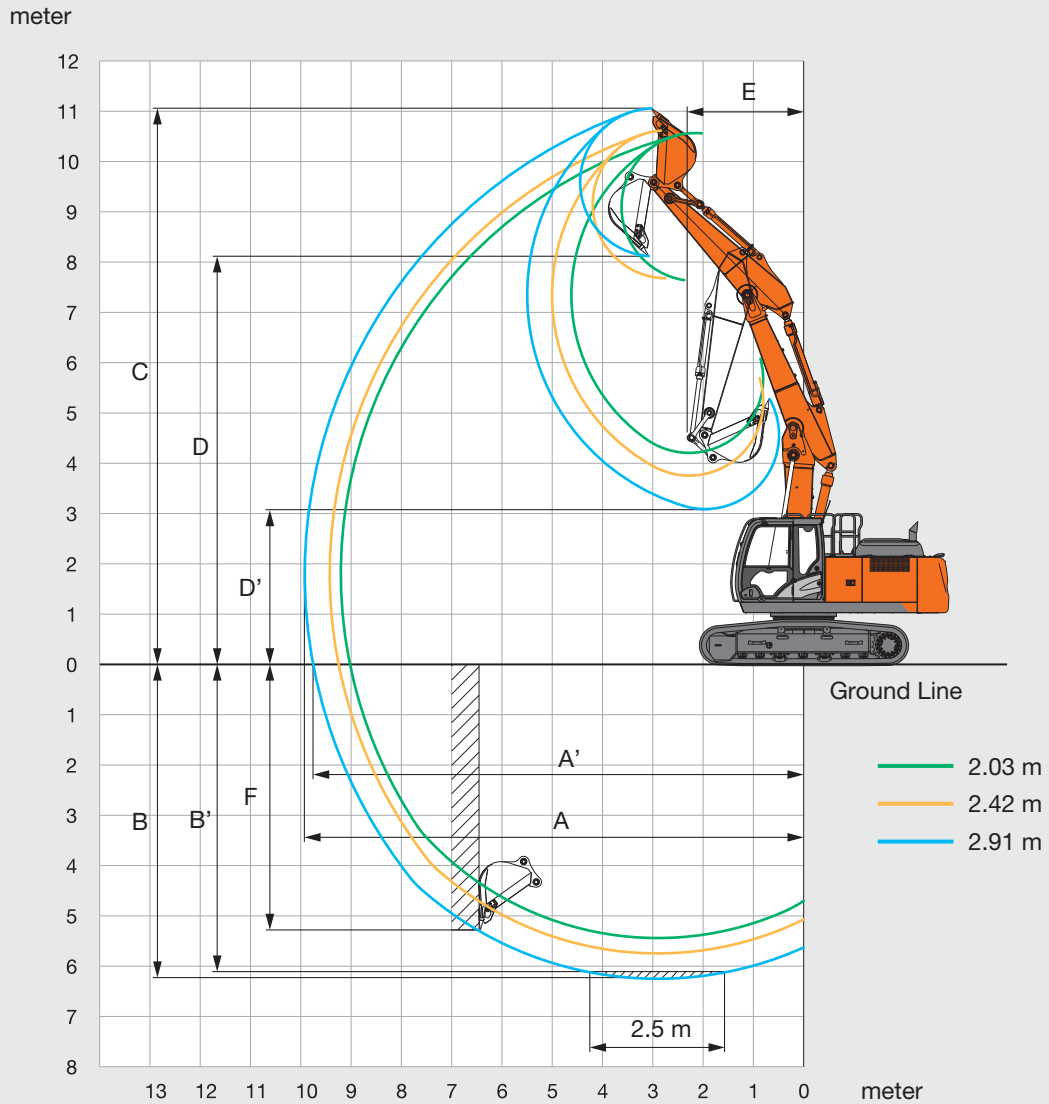

Unit: mm

	ZAXIS 210 / ZAXIS 210LC / ZAXIS 210LCN		
	2-Piece boom		
Arm length	2.03 m	2.42 m	2.91 m
A Max. digging reach	9 210	9 430	9 930
A' Max. digging reach (on ground)	9 020	9 250	9 750
B Max. digging depth	5 420	5 720	6 230
B' Max. digging depth for 2.5 m level	5 300	5 610	6 120
C Max. cutting height	10 590	10 640	11 080
D Max. dumping height	7 670	7 700	8 150
D' Min. dumping height	4 230	3 780	3 110
E Min. swing radius	2 630	2 630	2 320
F Max. vertical wall digging depth	4 560	4 720	5 280

Excluding track shoe lug

SPECIFICATIONS

DIMENSIONS

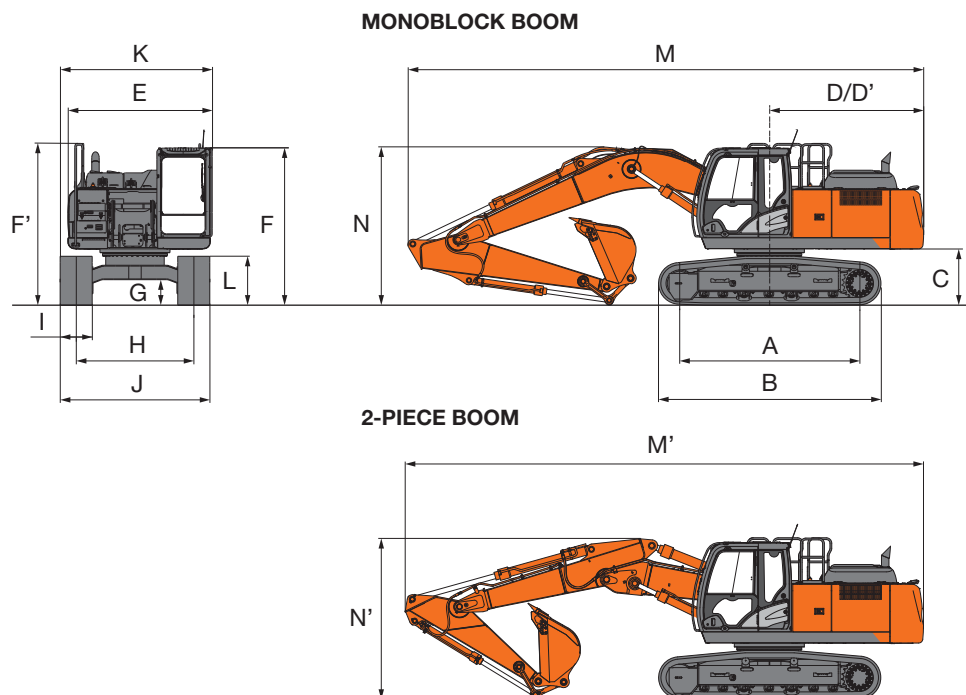

Unit: mm

	ZAXIS 210	ZAXIS 210LC	ZAXIS 210LCN
A Distance between tumblers	3370	3 660	3 660
B Undercarriage length	4 170	4 460	4 460
* C Counterweight clearance	990	990	990
D Rear-end swing radius	2 890	2 890	2 890
D' Rear-end length	2 890	2 890	2 890
E Overall width of upperstructure	2 710	2 710	2 480
F Overall height of cab	2 950	2 950	2 950
F' Overall height of upperstructure	3 020	3 020	3 020
* G Min. ground clearance	450	450	450
H Track gauge	2 200	2 390	1 980
I Track shoe width	G 600	G 600	G 500
J Undercarriage width	2 800	2 990	2 480
K Overall width	2 860	2 990	2 500
* L Track height with triple grouser shoes	920	920	920
MONOBLOCK BOOM			
M Overall length			
With arm 2.03 m	9 750	9 750	9 750
With arm 2.42 m	9 750	9 750	9 750
With arm 2.91 m	9 660	9 660	9 660
N Overall height of boom			
With arm 2.03 m	3 150	3 150	3 150
With arm 2.42 m	3 180	3 180	3 180
With arm 2.91 m	2 940	2 940	2 940
2-PIECE BOOM			
M' Overall length			
With arm 2.03 m	9 720	9 720	9 720
With arm 2.42 m	9 690	9 690	9 690
With arm 2.91 m	9 640	9 640	9 640
N' Overall height of boom			
With arm 2.03 m	3 010	3 010	3 010
With arm 2.42 m	3 060	3 060	3 060
With arm 2.91 m	2 910	2 910	2 910

* Excluding track shoe lug G: Triple grouser shoe

LIFTING CAPACITIES

- Notes: 1. Ratings are based on ISO 10567.
 2. Lifting capacity does not exceed 75% of tipping load with the machine on firm, level ground or 87% full hydraulic capacity.
 3. The load point is the center-line of the bucket pivot mounting pin on the arm.
 4. *Indicates load limited by hydraulic capacity.
 5. 0 m = Ground.

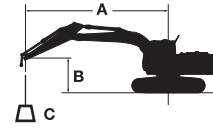

A: Load radius
 B: Load point height
 C: Lifting capacity

For lifting capacities, subtract bucket and quick hitch weight from lifting capacities.

ZAXIS 210 MONOBLOCK BOOM

Rating over-front Rating over-side or 360 degrees Unit : kg

Conditions	Load point height m	Load radius										At max. reach		
		1.5 m		3.0 m		4.5 m		6.0 m		7.5 m		meter		
Boom 5.68 m Arm 2.03 m Counterweight 4 850 kg Shoe 600 mm	6.0					*6 560	*6 560	*6 180	5 330			*6 260	4 670	6.50
	4.5					*7 870	*7 870	*6 570	5 210			*5 690	3 890	7.27
	3.0					*9 720	7 410	*7 320	5 000	5 360	3 650	5 180	3 530	7.67
	1.5							7 260	4 810	5 280	3 570	5 040	3 410	7.75
	0 (Ground)					11 040	6 920	7 130	4 700	5 240	3 530	5 200	3 510	7.54
	-1.5					*10 710	6 930	7 120	4 690			5 790	3 880	6.99
-3.0			*12 200	*12 200	*9 260	7 070	*6 540	4 830			*6 470	4 800	6.03	
Boom 5.68 m Arm 2.42 m Counterweight 4 850 kg Shoe 600 mm	6.0							*5 730	5 380			*5 760	4 460	6.74
	4.5					*7 310	*7 310	*6 210	5 230			5 460	3 730	7.48
	3.0					*9 180	7 480	*7 010	5 010	5 360	3 640	4 980	3 380	7.87
	1.5					*10 680	7 040	7 240	4 790	5 250	3 540	4 830	3 270	7.95
	0 (Ground)					10 980	6 860	7 090	4 660	5 180	3 480	4 970	3 340	7.74
	-1.5			*9 900	*9 900	*10 870	6 840	7 050	4 620			5 470	3 660	7.21
-3.0			*13 180	13 140	*9 690	6 940	*7 130	4 700			*6 640	4 440	6.28	
-4.5					*6 850	*6 850					*6 410	*6 410	4.71	
Boom 5.68 m Arm 2.91 m Counterweight 4 850 kg Shoe 600 mm	6.0							*5 200	*5 200			*4 030	3 950	7.32
	4.5					*6 590	*6 590	*5 750	5 290	*5 370	3 760	*3 970	3 370	8.01
	3.0					*8 500	7 620	*6 620	5 050	5 380	3 650	*4 080	3 090	8.37
	1.5					*10 230	7 130	7 280	4 820	5 250	3 540	*4 360	2 990	8.45
	0 (Ground)			*4 830	*4 830	11 000	6 870	7 090	4 650	5 160	3 450	4 520	3 040	8.25
	-1.5	*5 470	*5 470	*9 090	*9 090	10 920	6 800	7 010	4 580	5 130	3 430	4 910	3 290	7.76
-3.0	*9 960	*9 960	*14 340	12 970	*10 190	6 860	7 050	4 620			5 820	3 870	6.90	
-4.5			*11 210	*11 210	*8 090	7 070					*6 220	5 370	5.52	



ZAXIS 210LC MONOBLOCK BOOM













Rating over-front Rating over-side or 360 degrees Unit : kg

Conditions	Load point height m	Load radius										At max. reach		
		1.5 m		3.0 m		4.5 m		6.0 m		7.5 m		meter		
Boom 5.68 m Arm 2.03 m Counterweight 4 850 kg Shoe 600 mm	6.0					*6 560	*6 560	*6 180	5 870			*6 260	5 150	6.50
	4.5					*7 870	*7 870	*6 570	5 740			*6 200	4 290	7.27
	3.0					*9 720	8 260	*7 320	5 530	6 040	4 030	5 840	3 900	7.67
	1.5							*8 000	5 340	5 960	3 950	5 680	3 780	7.75
	0 (Ground)					*11 270	7 750	8 120	5 220	5 910	3 910	5 880	3 890	7.54
	-1.5					*10 710	7 770	*8 030	5 210			6 550	4 300	6.99
-3.0			*12 200	*12 200	*9 260	7 900	*6 540	5 350			*6 470	5 330	6.03	
Boom 5.68 m Arm 2.42 m Counterweight 4 850 kg Shoe 600 mm	6.0							*5 730	*5 730			*5 760	4 910	6.74
	4.5					*7 310	*7 310	*6 210	5 770			*5 790	4 110	7.48
	3.0					*9 180	8 330	*7 010	5 540	*6 030	4 020	5 610	3 740	7.87
	1.5					*10 680	7 880	*7 780	5 320	5 930	3 920	5 450	3 620	7.95
	0 (Ground)					*11 200	7 690	8 080	5 180	5 860	3 860	5 610	3 700	7.74
	-1.5			*9 900	*9 900	*10 870	7 670	8 040	5 140			6 190	4 060	7.21
-3.0			*13 180	*13 180	*9 690	7 780	*7 130	5 230			*6 640	4 930	6.28	
-4.5					*6 850	*6 850					*6 410	*6 410	4.71	
Boom 5.68 m Arm 2.91 m Counterweight 4 850 kg Shoe 600 mm	6.0							*5 200	*5 200			*4 030	*4 030	7.32
	4.5					*6 590	*6 590	*5 750	*5 750	*5 370	4 140	*3 970	3 720	8.01
	3.0					*8 500	8 480	*6 620	5 590	*5 730	4 040	*4 080	3 420	8.37
	1.5					*10 230	7 970	*7 490	5 350	5 940	3 920	*4 360	3 310	8.45
	0 (Ground)			*4 830	*4 830	*11 080	7 700	*8 070	5 180	5 840	3 830	*4 870	3 370	8.25
	-1.5	*5 470	*5 470	*9 090	*9 090	*11 050	7 630	8 000	5 110	5 810	3 810	5 550	3 650	7.76
-3.0	*9 960	*9 960	*14 340	*14 340	*10 190	7 690	*7 560	5 140			*6 220	4 300	6.90	
-4.5			*11 210	*11 210	*8 090	7 910					*6 220	5 970	5.52	



LIFTING CAPACITIES













ZAXIS 210LCN MONOBLOCK BOOM

 Rating over-front  Rating over-side or 360 degrees Unit : kg

Conditions	Load point height m	Load radius										At max. reach		meter
		1.5 m		3.0 m		4.5 m		6.0 m		7.5 m				
														
Boom 5.68 m Arm 2.03 m Counterweight 4 700 kg Shoe 500 mm	6.0					*6 560	*6 560	*6 180	4 860			*6 260	4 250	6.50
	4.5					*7 870	7 170	*6 570	4 730			*6 200	3 530	7.27
	3.0					*9 720	6 670	*7 320	4 530	5 860	3 310	5 670	3 200	7.67
	1.5							*8 000	4 350	5 780	3 230	5 510	3 090	7.75
	0 (Ground)					*11 270	6 190	7 880	4 240	5 740	3 200	5 700	3 180	7.54
	-1.5					*10 710	6 200	7 870	4 230			6 350	3 510	6.99
	-3.0			*12 200	11 720	*9 260	6 330	*6 540	4 360			*6 470	4 340	6.03
Boom 5.68 m Arm 2.42 m Counterweight 4 700 kg Shoe 500 mm	6.0							*5 730	4 900			*5 760	4 060	6.74
	4.5					*7 310	7 250	*6 210	4 760			*5 790	3 390	7.48
	3.0					*9 180	6 730	*7 010	4 540	5 860	3 300	5 450	3 070	7.87
	1.5					*10 680	6 310	*7 780	4 330	5 760	3 200	5 290	2 950	7.95
	0 (Ground)					*11 200	6 120	7 840	4 190	5 680	3 140	5 440	3 020	7.74
	-1.5			*9 900	*9 900	*10 870	6 110	7 800	4 160			6 000	3 300	7.21
	-3.0			*13 180	11 500	*9 690	6 210	*7 130	4 240			*6 640	4 010	6.28
Boom 5.68 m Arm 2.91 m Counterweight 4 700 kg Shoe 500 mm	6.0							*5 200	4 970			*4 030	3 590	7.32
	4.5					*6 590	*6 590	*5 750	4 810	*5 370	3 420	*3 970	3 060	8.01
	3.0					*8 500	6 870	*6 620	4 580	*5 730	3 310	*4 080	2 800	8.37
	1.5					*10 230	6 390	*7 490	4 350	5 760	3 200	*4 360	2 700	8.45
	0 (Ground)			*4 830	*4 830	*11 080	6 140	7 840	4 190	5 660	3 120	*4 870	2 750	8.25
	-1.5	*5 470	*5 470	*9 090	*9 090	*11 050	6 070	7 760	4 120	5 630	3 090	5 380	2 970	7.76
	-3.0	*9 960	*9 960	*14 340	11 340	*10 190	6 130	*7 560	4 160			*6 220	3 490	6.90
-4.5			*11 210	*11 210	*8 090	6 330					*6 220	4 840	5.52	

ZAXIS 210 2-PIECE BOOM

 Rating over-front  Rating over-side or 360 degrees Unit : kg

Conditions	Load point height m	Load radius										At max. reach		meter
		1.5 m		3.0 m		4.5 m		6.0 m		7.5 m				
														
2-Piece Boom Arm 2.03 m Counterweight 4 850 kg Shoe 600 mm	9.0											*11 800	*11 800	2.56
	7.5					*7 440	*7 440					*6 640	*6 640	5.17
	6.0			*7 930	*7 930	*7 390	*7 390	*6 190	5 400			*5 460	4 670	6.48
	4.5			*11 500	*11 500	*8 450	8 180	*6 360	5 440			*4 980	3 860	7.25
	3.0			*13 200	*13 200	*10 650	*8 000	*7 030	5 330	5 380	3 620	*4 830	3 490	7.65
	1.5			*15 440	14 300	*11 170	7 920	*7 470	5 120	5 300	3 550	*4 910	3 380	7.73
	0 (Ground)	*11 090	*11 090	*17 350	13 720	*11 190	7 480	7 410	4 890	5 230	3 490	5 220	3 480	7.52
2-Piece Boom Arm 2.42 m Counterweight 4 850 kg Shoe 600 mm	-1.5	*19 550	*19 550	*17 650	13 430	*11 410	7 250	7 240	4 740			*5 320	3 860	6.97
	-3.0	*29 440	*29 440	*16 070	13 490	*9 740	7 120					*5 450	5 040	5.77
	9.0			*9 080	*9 080							*8 690	*8 690	3.19
	7.5					*6 910	*6 910					*5 880	*5 880	5.50
	6.0					*6 990	*6 990	*5 790	5 500			*4 960	4 430	6.74
	4.5			*12 150	*12 150	*7 910	*7 910	*6 050	5 460			*4 580	3 690	7.48
	3.0			*13 680	*13 680	*10 080	7 990	*6 700	5 330	*5 310	3 650	*4 470	3 340	7.87
2-Piece Boom Arm 2.91 m Counterweight 4 850 kg Shoe 600 mm	1.5			*15 360	14 180	*11 060	*7 930	7 430	5 150	5 310	3 550	*4 560	3 220	7.95
	0 (Ground)	*12 330	*12 330	*17 110	13 810	*11 080	7 520	7 370	4 890	5 200	3 450	*4 890	3 290	7.74
	-1.5	*18 400	*18 400	*17 470	13 390	*11 230	7 220	7 190	4 690			5 470	3 620	7.21
	-3.0	*24 600	*24 600	*16 730	13 330	*10 350	7 010	*5 930	4 670			*4 930	4 440	6.25
	9.0											*5 410	*5 410	4.30
	7.5					*6 080	*6 080	*5 050	*5 050			*4 420	*4 420	6.20
	6.0					*6 260	*6 260	*5 420	*5 420			*4 080	3 920	7.32
2-Piece Boom Arm 2.91 m Counterweight 4 850 kg Shoe 600 mm	4.5			*8 230	*8 230	*7 310	*7 310	*5 700	*5 490	*4 780	3 800	*4 000	3 340	8.01
	3.0	*10 970	*10 970	*14 280	*14 280	*9 160	8 030	*6 330	*5 360	*5 030	3 740	*3 990	3 050	8.37
	1.5	*8 820	*8 820	*14 880	*14 130	*10 880	7 800	*7 250	5 200	*5 360	3 620	*4 070	2 950	8.45
	0 (Ground)	*11 160	*11 160	*16 560	14 070	*11 040	7 620	*7 350	5 000	5 240	3 490	*4 320	3 000	8.25
	-1.5	*15 150	*15 150	*17 320	13 470	*11 110	7 270	7 250	4 740	5 150	3 400	*4 840	3 250	7.76
	-3.0	*19 200	*19 200	*17 390	13 320	*11 010	7 020	7 120	4 620			*4 690	3 840	6.91
	-4.5	*20 970	*20 970	*12 840	*12 840	*7 180	7 060					*7 000	6 900	4.57

ZAXIS 210LC 2-PIECE BOOM

Rating over-front

Rating over-side or 360 degrees

Unit : kg

Conditions	Load point height m	Load radius										At max. reach		
		1.5 m		3.0 m		4.5 m		6.0 m		7.5 m				meter
2-Piece Boom Arm 2.03 m Counterweight 4 850 kg Shoe 600 mm	9.0											*11 800	*11 800	2.56
	7.5					*7 440	*7 440					*6 640	*6 640	5.17
	6.0			*7 930	*7 930	*7 390	*7 390	*6 190	5 940			*5 460	5 150	6.48
	4.5			*11 500	*11 500	*8 450	*8 450	*6 360	5 940			*4 980	4 270	7.25
	3.0			*13 200	*13 200	*10 650	8 750	*7 030	5 820	*5 400	4 010	*4 830	3 870	7.65
	1.5			*15 440	*15 440	*11 170	*8 600	*7 990	5 670	*5 820	3 940	*4 910	3 750	7.73
	0 (Ground)	*11 090	*11 090	*17 350	15 680	*11 190	8 350	*8 240	5 430	*5 320	3 870	*5 240	3 860	7.52
	-1.5	*19 550	*19 550	*17 650	15 380	*11 410	8 100	*8 010	5 270			*5 320	4 290	6.97
	-3.0	*29 440	*29 440	*16 070	15 440	*9 740	7 970					*5 450	*5 450	5.77
2-Piece Boom Arm 2.42 m Counterweight 4 850 kg Shoe 600 mm	9.0			*9 080	*9 080							*8 690	*8 690	3.19
	7.5					*6 910	*6 910					*5 880	*5 880	5.50
	6.0					*6 990	*6 990	*5 790	*5 790			*4 960	4 890	6.74
	4.5			*12 150	*12 150	*7 910	*7 910	*6 050	*5 930			*4 580	4 080	7.48
	3.0			*13 680	*13 680	*10 080	8 710	*6 700	5 820	*5 310	4 040	*4 470	3 700	7.87
	1.5			*15 360	*15 360	*11 060	8 540	*7 650	5 680	*5 680	3 940	*4 560	3 580	7.95
	0 (Ground)	*12 330	*12 330	*17 110	15 780	*11 080	8 380	*8 150	5 430	*5 840	3 840	*4 890	3 660	7.74
	-1.5	*18 400	*18 400	*17 470	15 330	*11 230	8 080	*8 140	5 230			*5 500	4 020	7.21
	-3.0	*24 600	*24 600	*16 730	15 270	*10 350	7 860	*5 930	5 210			*4 930	*4 930	6.25
2-Piece Boom Arm 2.91 m Counterweight 4 850 kg Shoe 600 mm	9.0											*5 410	*5 410	4.30
	7.5					*6 080	*6 080	*5 050	*5 050			*4 420	*4 420	6.20
	6.0					*6 260	*6 260	*5 420	*5 420			*4 080	*4 080	7.32
	4.5			*8 230	*8 230	*7 310	*7 310	*5 700	*5 700	*4 780	4 190	*4 000	3 700	8.01
	3.0	*10 970	*10 970	*14 280	*14 280	*9 160	8 740	*6 330	*5 830	*5 030	4 130	*3 990	3 390	8.37
	1.5	*8 820	*8 820	*14 880	*14 880	*10 880	8 570	*7 250	5 690	*5 400	4 010	*4 070	3 270	8.45
	0 (Ground)	*11 160	*11 160	*16 660	15 690	*11 040	8 500	*8 110	5 540	*5 850	3 870	*4 320	3 340	8.25
	-1.5	*15 150	*15 150	*17 320	15 420	*11 110	8 130	*8 180	5 270	5 840	3 790	*4 840	3 620	7.76
	-3.0	*19 200	*19 200	*17 390	15 270	*11 010	7 870	*7 310	5 160			*4 690	4 280	6.91
-4.5	*20 970	*20 970	*12 840	*12 840	*7 180	*7 180					*7 000	*7 000	4.57	

ZAXIS 210LCN 2-PIECE BOOM

Rating over-front

Rating over-side or 360 degrees

Unit : kg

Conditions	Load point height m	Load radius										At max. reach		
		1.5 m		3.0 m		4.5 m		6.0 m		7.5 m				meter
2-Piece Boom Arm 2.03 m Counterweight 4 700 kg Shoe 500 mm	9.0											*11 800	*11 800	2.56
	7.5					*7 440	*7 440					*6 640	6 070	5.17
	6.0			*7 930	*7 930	*7 390	*7 390	*6 190	4 910			*5 460	4 240	6.48
	4.5			*11 500	*11 500	*8 450	7 530	*6 360	4 950			*4 980	3 500	7.25
	3.0			*13 200	12 950	*10 650	7 310	*7 030	4 840	*5 400	3 270	*4 830	3 160	7.65
	1.5			*15 440	12 820	*11 170	7 140	*7 990	4 640	5 820	3 200	*4 910	3 050	7.73
	0 (Ground)	*11 090	*11 090	*17 350	12 030	*11 190	6 720	8 120	4 420	*5 320	3 140	*5 240	3 140	7.52
	-1.5	*19 550	*19 550	*17 650	11 750	*11 410	6 490	8 000	4 260			*5 320	3 480	6.97
	-3.0	*29 440	*29 440	*16 070	11 810	*9 740	6 360					*5 450	4 530	5.77
2-Piece Boom Arm 2.42 m Counterweight 4 700 kg Shoe 500 mm	9.0			*9 080	*9 080							*8 690	*8 690	3.19
	7.5					*6 910	*6 910					*5 880	5 600	5.50
	6.0					*6 990	*6 990	*5 790	5 010			*4 960	4 020	6.74
	4.5			*12 150	*12 150	*7 910	7 530	*6 050	5 030			*4 580	3 340	7.48
	3.0			*13 680	12 910	*10 080	7 330	*6 700	4 900	*5 310	3 300	*4 470	3 020	7.87
	1.5			*15 360	12 810	*11 060	7 220	*7 650	4 670	*5 680	3 200	*4 560	2 900	7.95
	0 (Ground)	*12 330	*12 330	*17 110	12 110	*11 080	6 750	8 060	4 410	5 720	3 110	*4 890	2 960	7.74
	-1.5	*18 400	*18 400	*17 470	11 710	*11 230	6 460	7 960	4 220			*5 500	3 250	7.21
	-3.0	*24 600	*24 600	*16 730	11 650	*10 350	6 260	*5 930	4 200			*4 930	3 990	6.25
2-Piece Boom Arm 2.91 m Counterweight 4 700 kg Shoe 500 mm	9.0											*5 410	*5 410	4.30
	7.5					*6 080	*6 080	*5 050	4 970			*4 420	*4 420	6.20
	6.0					*6 260	*6 260	*5 420	5 140			*4 080	3 560	7.32
	4.5			*8 230	*8 230	*7 310	*7 310	*5 700	*5 070	*4 780	3 450	*4 000	3 020	8.01
	3.0	*10 970	*10 970	*14 280	13 000	*9 160	7 370	*6 330	4 930	*5 030	3 390	*3 990	2 750	8.37
	1.5	*8 820	*8 820	*14 880	12 810	*10 880	7 120	*7 250	4 770	*5 400	3 270	*4 070	2 650	8.45
	0 (Ground)	*11 160	*11 160	*16 560	12 360	*11 040	6 850	*8 000	4 520	5 760	3 140	*4 320	2 700	8.25
	-1.5	*15 150	*15 150	*17 320	11 780	*11 110	6 510	8 020	4 260	5 670	3 060	*4 840	2 920	7.76
	-3.0	*19 200	*19 200	*17 390	11 640	*11 010	6 270	*7 310	4 150			*4 690	3 450	6.91
-4.5	*20 970	*20 970	*12 840	11 670	*7 180	6 300					*7 000	6 170	4.57	

EQUIPMENT

● : Standard equipment

○ : Optional equipment

ENGINE

Aftertreatment device	●
Air cleaner double filters	●
Alternator 50 A	●
Auto idle system	●
Auto shut-down control	●
Cartridge-type engine oil filter	●
Cartridge-type fuel main filter	●
Cold fuel resistance valve	●
DEF/AdBlue® tank inlet strainer and extension filter	●
DEF/AdBlue® tank with ISO magnet adapter	●
Dry-type air filter with evacuator valve (with air filter restriction indicator)	●
Dust-proof indoor net	●
ECO/PWR mode control	●
Electrical fuel feed pump	●
Engine oil drain coupler	●
Expansion tank	●
Fan guard	●
Fuel cooler	●
Fuel pre-filter with water separator	●
Isolation-mounted engine	●
Maintenance free pre-cleaner	○
Radiator, oil cooler and intercooler	●

HYDRAULIC SYSTEM

Auto power lift	●
Control valve with main relief valve	●
Full-flow filter	●
High mesh full flow filter with restriction indicator	○
Hose rupture valve for arm	●
Hose rupture valve for boom	●
Pilot filter	●
Power boost	●
Suction filter	●
Swing dampener valve	●
Two extra port for control valve	●
Variable reliefvalve for breaker & crusher	●
Work mode selector	●

CAB

All-weather sound suppressed steel cab	●
AM-FM radio	●
Ashtray	●
Auto control air conditioner	●
AUX function lever (Breaker assist)	○
AUX terminal and storage	●
Cigarette lighter 24 V	●
CRES V (Center pillar reinforced structure) cab	●
Drink holder with hot & cool function	●
Electric double horn	●
Engine shut-off switch	●
Equipped with reinforced, tinted (green color) glass windows	●
Evacuation hammer	●
Floor mat	●
Footrest	●
Front window washer	●
Glove compartment	●
Hot & cool box	●
Intermittent windshield wipers	●
Key cylinder light	●
Laminated round glass window	○
LED room light with door courtesy	●
OPG front guard Level II (ISO10262) compliant cab	○
OPG top guard Level I (ISO10262) compliant cab	●
OPG top guard Level II (ISO10262) compliant cab	○
Pilot control shut-off lever	●
Power outlet 12 V	○
Rain guard	○
Rear tray	●
Retractable seat belt	●
ROPS (ISO12117-2) compliant cab	●
Rubber radio antenna	●
Seat : air suspension seat with heater	●
Seat adjustment part : backrest, armrest, height and angle, slide forward / back	●
Short wrist control levers	●
Sun visor (front window/side window)	○
Transparent roof with slide curtain	●
Windows on front, upper, lower and left side can be opened	●
2 speakers	●
4 fluid-filled elastic mounts	●

MONITOR SYSTEM

Alarms: overheat, engine warning, engine oil pressure, alternator, minimum fuel level, hydraulic filter restriction, air filter restriction, work mode, overload, SCR system trouble, etc	●
Alarm buzzers: overheat, engine oil pressure, overload, SCR system trouble	●
Display of meters: water temperature, hour, fuel rate, clock, DEF/AdBlue® rate	●
Other displays: work mode, auto-idle, glow, rearview monitor, operating conditions, etc	●
32 languages selection	●

LIGHTS

Additional boom light with cover	○
Additional cab roof front lights	○
Additional cab roof rear lights	○
Rotating lamp	○
2 working lights	●

UPPER STRUCTURE

Batteries 2 x 126 Ah	●
Battery disconnect switch	●
Body top handrail	●
Counterweight 4 250 kg : ZAXIS 210 / ZAXIS 210LC	○
Counterweight 4 850 kg : ZAXIS 210 / ZAXIS 210LC	●
Counterweight 4 700 kg : ZAXIS 210LCN	●
Electric fuel refilling pump with auto stop and filter	●
Fuel level float	●
Hydraulic oil level gauge	●
Lockable fuel refilling cap	●
Lockable machine covers	●
Lockable tool box	●
Platform handrail	●
Rear view camera	●
Rear view mirror (right & left side)	●
Skid-resistant plates and handrails	●
Swing parking brake	●
Undercover	●
Utility space	●

UNDERCARRIAGE

Bolt-on sprocket	●
Reinforced track links with pin seals	●
Shoe: 600 mm triple grouser : ZAXIS 210 / ZAXIS 210LC	●
Shoe: 500 mm triple grouser : ZAXIS 210LCN	●
Track undercover	○
Travel direction mark on track frame	●
Travel motor covers	●
Travel parking brake	●
Upper and lower rollers	●
2 track guards (each side) and hydraulic track adjuster : ZAXIS 210 / ZAXIS 210LC / ZAXIS 210LCN	●
3 track guards (each side) and hydraulic track adjuster : ZAXIS 210LC / ZAXIS 210LCN	○
4 tie down brackets	●

FRONT ATTACHMENTS

Casted bucket link A	●
Centralized lubrication system	●
Dirt seal on all bucket pins	●
Flanged pin	●
HN bushing	●
Reinforced resin thrust plate	●
WC (tungsten-carbide) thermal spraying	●
Welded bucket link A	○
Welded bucket link A with welded hook	○

ATTACHMENTS

Accessories for 2 speed selector : ZAXIS 210 / ZAXIS 210LC	○
Accessories for 2 speed selector : ZAXIS 210LCN	●
Additional pump (30 L/min)	○
Assist piping	○
Attachment basic piping	●
Breaker and crusher piping	●
Parts for breaker and crusher	●
Pilot accumulator	○

MISCELLANEOUS

Global e-Service	●
Onboard information controller	●
Standard tool kit	●

Standard and optional equipment may vary by country, so please consult your Hitachi dealer for details.

Prior to operating this machine, including satellite communication system, in a country other than a country of its intended use, it may be necessary to make modifications to it so that it complies with the local regulatory standards (including safety standards) and legal requirements of that particular country. Please do not export or operate this machine outside the country of its intended use until such compliance has been confirmed. Please contact your Hitachi dealer in case of questions about compliance.

These specifications are subject to change without notice. Illustrations and photos show the standard models, and may or may not include optional equipment, accessories, and all standard equipment with some differences in color and features. Before use, read and understand the Operator's Manual for proper operation.

